

ASAHI SASUKE: the next generation of dual lumen microcatheter

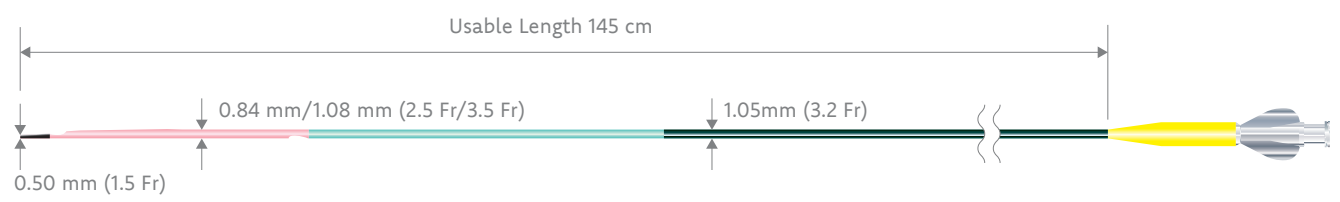

ORDERING INFORMATION

Catalog Number	Outer Diameter			Inner Diameter		Usable Length	Recommended Guide Wire	Hydrophillic Coating Length
	Tip	Distal	Proximal	Tip	Proximal			
SA145-33N	0.50 mm (1.5 F)	0.84 mm/1.08 mm (2.5 F/3.3 F)	1.05 mm (3.2 F)	0.40 mm (0.016 in.)	0.43 mm (0.017 in.)	145 cm	0.36 mm (0.014 in.)	38 cm

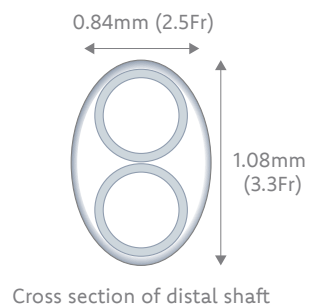
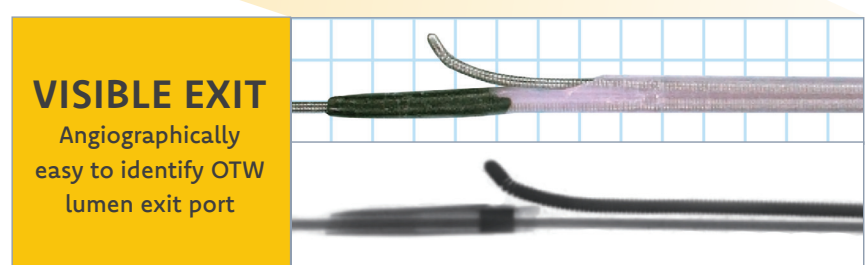
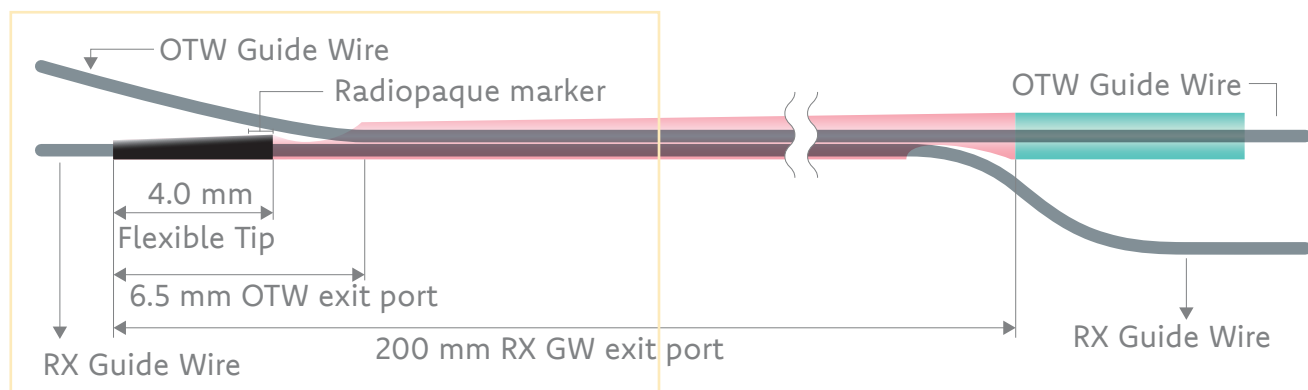

ASAHI INTECC USA, INC.
Toll Free: 855-286-9473 Fax: 949-756-8146

WWW.ASAHI-INTECC-US.COM

©2019 ASAHI INTECC CO., LTD.
"ASAHI", "SASUKE", "Corsair Pro" and "Caravel" are trademarks or registered trademarks of ASAHI INTECC CO., LTD. in Japan and other countries. All other trademarks are the property of their respective owners.
K19240_B_LC_1.0 MKT0384 Rev A.

ASAHI SASUKE

NEXT GENERATION DUAL LUMEN MICROCATHETER



ASAHI INTECC USA, INC.



ASAHI SASUKE

DELIVERING STABILITY AND CONTROL TO COMPLEX PCI PROCEDURES

1 IMPROVED DESIGN

6.5 mm tip to OTW port negates the need for deep engagement in side branches and complex lesions

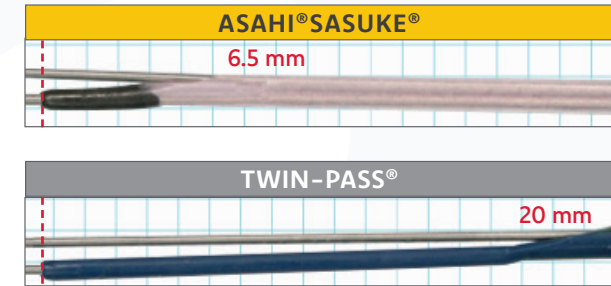

Source: TWIN-PASS® brochure

2 DOUBLE STAINLESS STEEL CORE

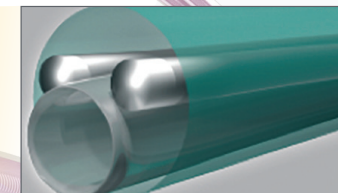

Double stainless steel core in proximal shaft improves kink resistance and pushability

3 TAPERED SOFT TIP

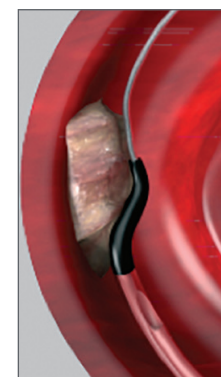

Incorporates the same tapered soft tip used in ASAHI Corsair Pro® and ASAHI Caravel® to maintain trackability in tortuous vessels

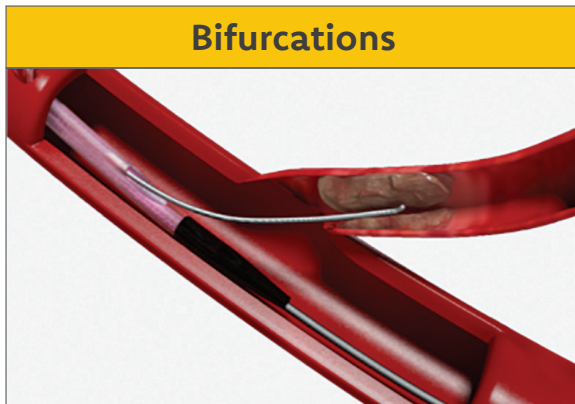
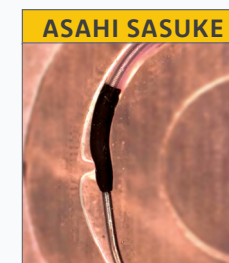

Bifurcations



Complex Lesions

Rx lumen guide wire and distal tip anchor the OTW exit port for greater push force and control.